

# Type 30 Tap Handle

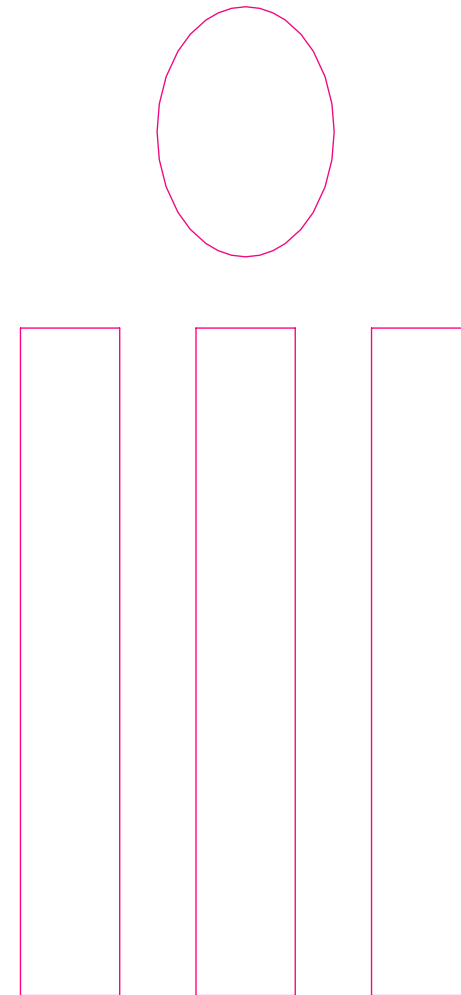

© Porter Lancastrian

## Cutter Guide

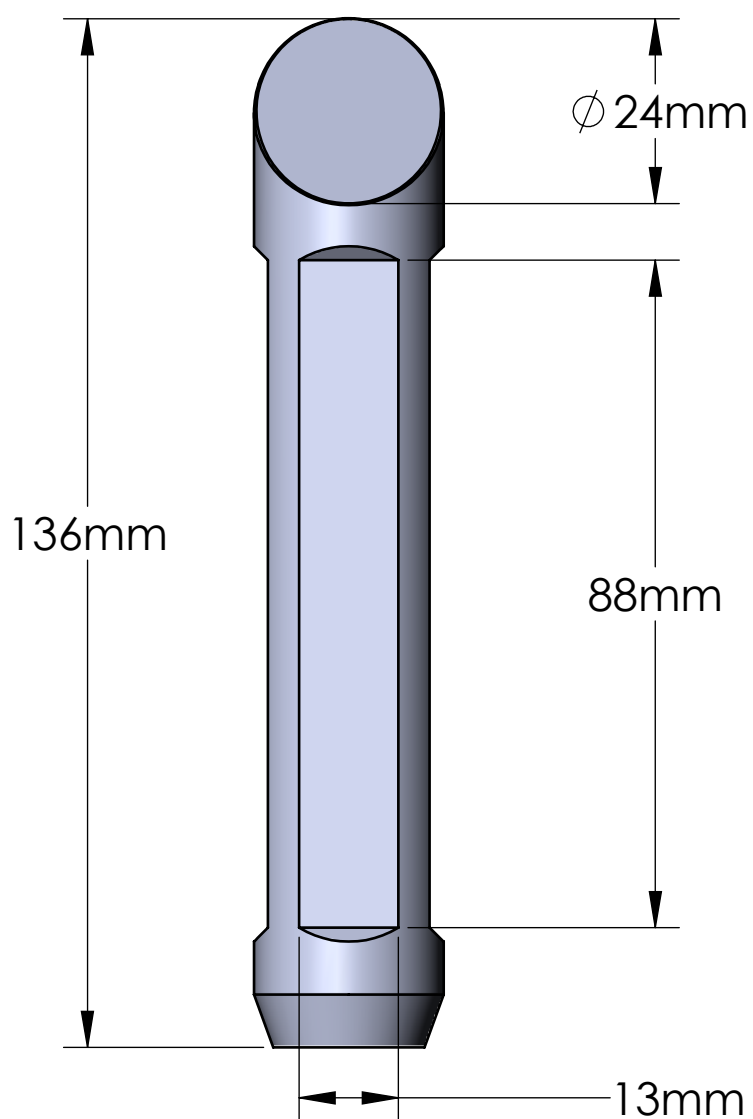

- Standard finish chrome
- Available in other finishes on request
- Minimum order quantities may apply
- Suitable for soft touch branding subject to artwork
- 10 mm or 3/8" tap thread fitting available